

DATASHEET

Comata

A6111H • gigaNOVA®



Features

- Designed for 2.4GHz applications: Bluetooth®, Wi-Fi® (802.11a/b/g/n), ZigBee®, etc.
- Designed for use with the ground plane extended beneath the antenna
- Easy to integrate
- Low profile design
- High efficiency
- Intended for SMD mounting
- Supplied in tape and reel

Note: This product is compatible with Bluetooth® technology but does not incorporate Bluetooth® technology

1. Description

Comata is intended for use with all 2.4 GHz applications. The antenna uses a ground plane in order to radiate efficiently and the ground plane must extend underneath the antenna itself.

2. Applications

- Wearables
- Notebooks
- PC cards
- Sensors

3. General data

Frequency	2.4 – 2.5GHz
Polarization	Linear
Operating temperature	-40°C to 140°C
Environmental condition test	ISO16750-4 5.1.1.1/5.1.2.1/5.3.2
Impedance with matching	50 Ω
Weight	<0.3g
Antenna type	SMD
Dimensions	12.8 x 3.6 x 3.3 (mm)

4. Part number

A6111H

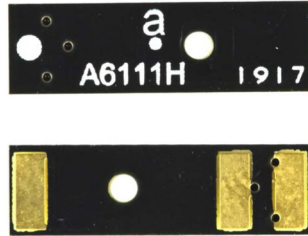

5. RF characteristics

Frequency	2.4 - 2.5 GHz
Peak gain	0.0dBi
Average gain	-3.5dBi
Average efficiency	45%
Maximum return loss	-8dB
Maximum VSWR	2.3:1

All data measured on Antenova's evaluation PCB Part No. A6111H-EVB-1

6. RF performance

6.1. Return loss

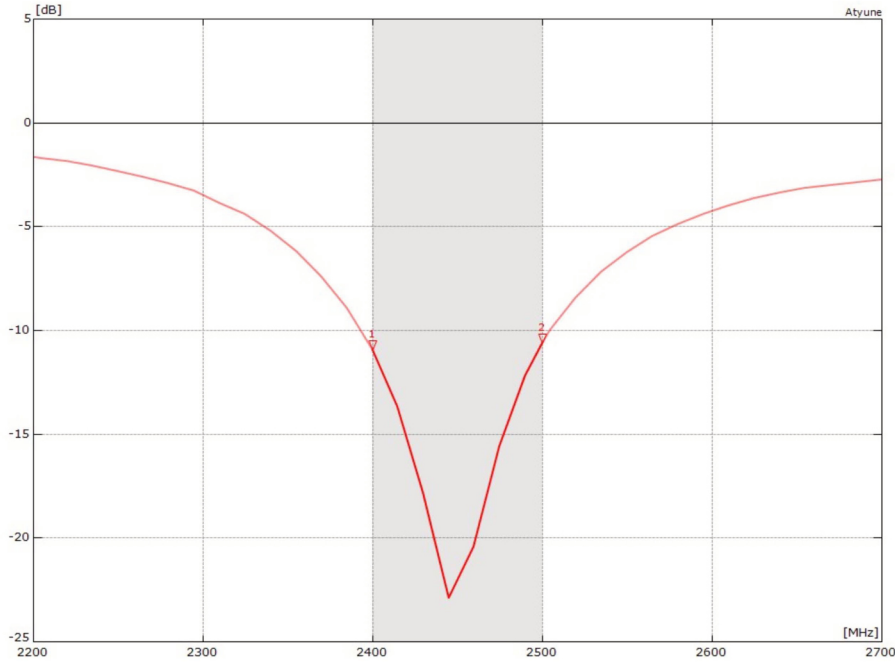

All data measured on Antenova's evaluation PCB Part No. A6111H-EVB-1 (EVK size 45mm x 35mm)

6.2. VSWR

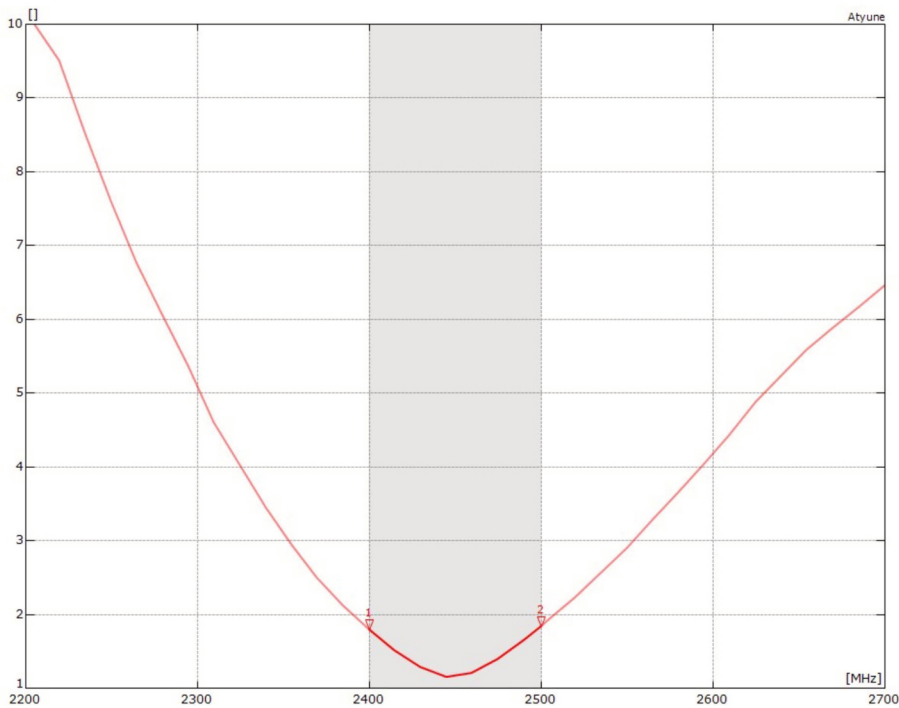

All data measured on Antenova's evaluation PCB Part No. A6111H-EVB-1 (EVK size 45mm x 35mm)

6.3. Antenna pattern

6.3.1. 2400 – 2500 MHz

3D pattern at 2450MHz

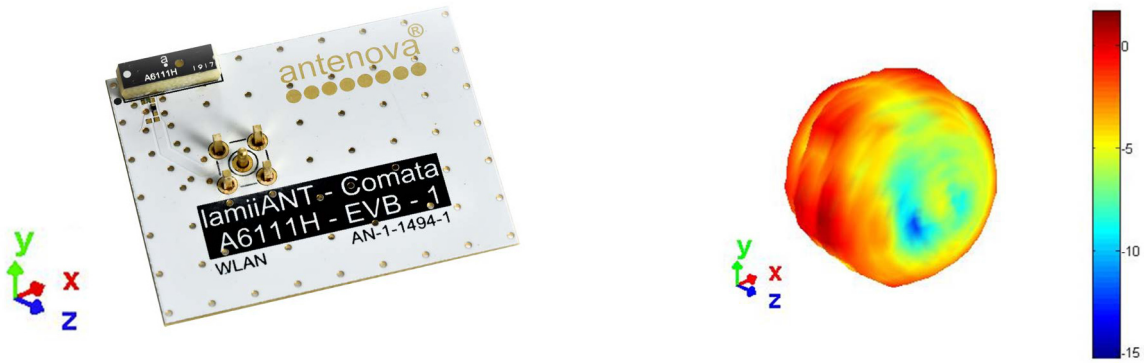

XY

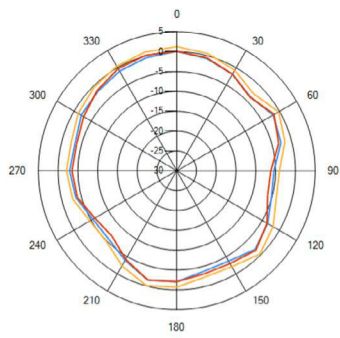

XZ

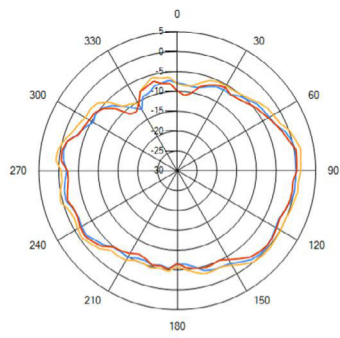

YZ

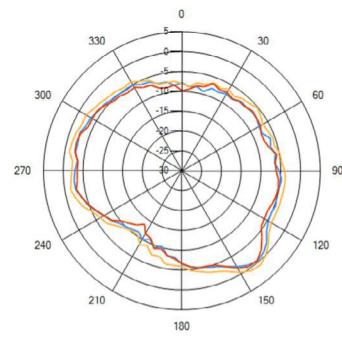

— 2.4GHz — 2.45GHz — 2.5GHz

7. Antenna dimensions

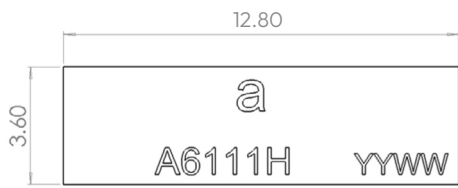
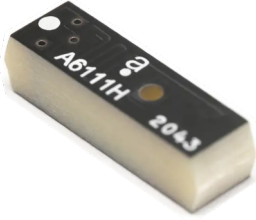

Top view



Bottom view

L	W	H
Length	Width	Height
12.8 ±0.2	3.6 ±0.2	3.3 ±0.2

All dimensions in (mm)

8. Schematic symbol and pin definition

The circuit symbol for the antenna is shown below. The antenna has 3 pins with only 1 as functional. All other pins are for mechanical strength.

Pin	Description
2	Feed (Transceiver port)
1, 3	GND

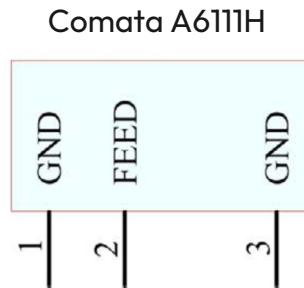

9. Host PCB footprint

The recommended host PCB footprint is below.

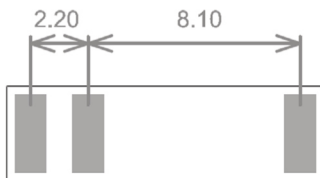

ALL PADS = 3.0 X 1.2 (MM)
ALL DIMENSIONS IN MM

Pads 1-3 = 3.0 x 1.2 (mm)

10. Electrical interface

10.1. Transmission line

All transmission lines should be designed to have a characteristic impedance of 50Ω .

- The length of each transmission lines should be kept to a minimum
- All other parts of the RF system like transceivers, power amplifiers, etc, should also be designed to have a 50Ω impedance

A co-planar transmission line can be designed using an online transmission line calculator tool, such as:

<https://blog.antenova.com/rf-transmission-line-calculator>

The PCB thickness, copper thickness and substrate dielectric constant are entered, then the tool calculates the transmission line width and gaps on either side of the track to give a 50Ω impedance.

10.2. Matching circuit

The antenna requires a matching circuit that must be optimized for each product. The matching circuit will require up to three components and the following circuit should be designed into the host PCB. Not all components may be required but should be included as a precaution. The matching network should be placed close to the antenna feed to ensure it is optionally effective in tuning the antenna.

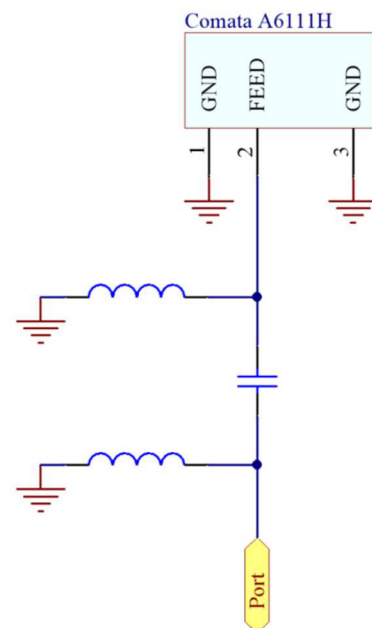

11. Antenna integration guide

We recommend the following during the design phase to maximise antenna performance and minimize noise:

- Minimum 4 layer PCB
- Route signals and power internally where possible
- Flood all layers with ground
- Knit ground on all layers together with plenty of vias

Follow placement guidance carefully. Antenova provide technical support to help you with your design, and also provide design assistance on PTCRB certification. Register for an account on <https://ask.antenova.com/> to access technical support.

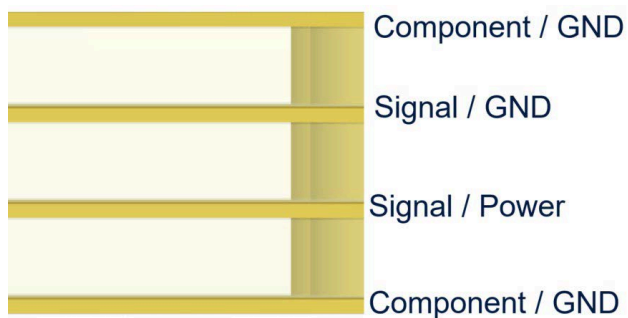

11.1. Antenna placement

The best position for the antenna is placing the antenna at the edge of the board. Maximum antenna performance is achieved by placing the antenna towards one of the corners of the PCB and with the feed point of the antenna as close to same corner of the PCB as possible.

The Antenova placement tool can be used to advise on antenna placement, see: <https://blog.antenova.com/intelligent-antenna-selection-and-placement-tool-antenova>

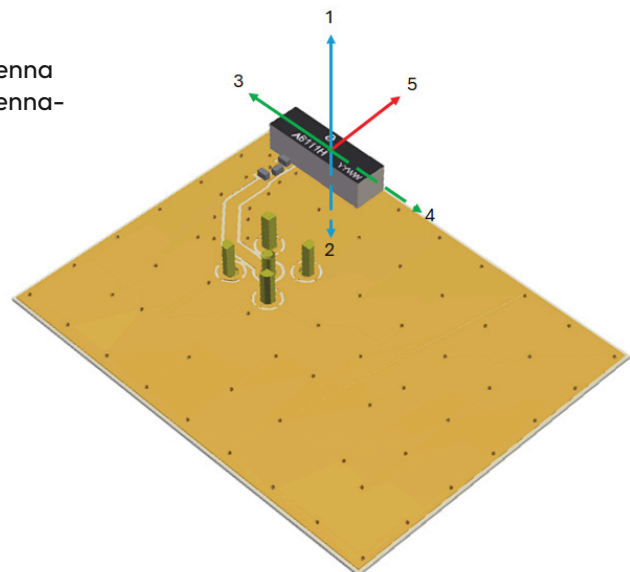

12. Reference board

A reference board is used for evaluating the antenna A6111H and it includes a SMA female connector. (Part number: A6111H-EVB-1)

To order a reference board please see antenna.com

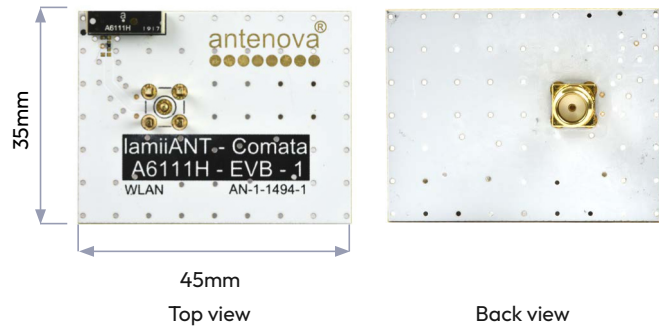

12.1. Reference board matching circuit

Designator	Type	Value	Description
L1	Inductor	Not fitted	Not fitted
L2	Inductor	2.7nH	Murata LQG15HN series
C2	Capacitor	1.0pF	Murata GJM15 series

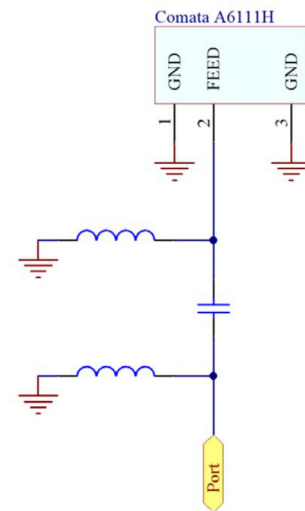

13. Soldering

This antenna is suitable for lead free soldering. The reflow profile should be adjusted to suit the device, oven and solder paste, while observing the following conditions:

- For leaded soldering, the maximum temperature should not exceed 240 °C.
- For lead free soldering, a maximum temperature of 255 °C for no more than 20 seconds is permitted.
- The antenna should not be exposed to temperatures exceeding 120 °C more than 3 times during the soldering process.

14. Hazardous material regulation conformance

The antenna has been tested to conform to RoHS and REACH requirements. A certificate of conformance is available from Antenova's website.

15. Packaging

15.1. Optimal storage conditions

Temperature	-10°C to 40°C
Humidity	Less than 75% RH
Shelf life	24 Months
Storage place	Away from corrosive gas and direct sunlight
Packaging	Reels should be stored in unopened sealed manufacturer's plastic packaging.
MSL Level	1

Note: Storage of open reels of antennas is not recommended due to possible oxidization of pads on antennas. If short term storage is necessary, then it is highly recommended that the bag containing the antenna reel is re-sealed and stored in conditions as described in the table above.

The shelf life of the antenna is 2 years provided the factory seal on the package has not been broken.

15.2. Tape characteristics

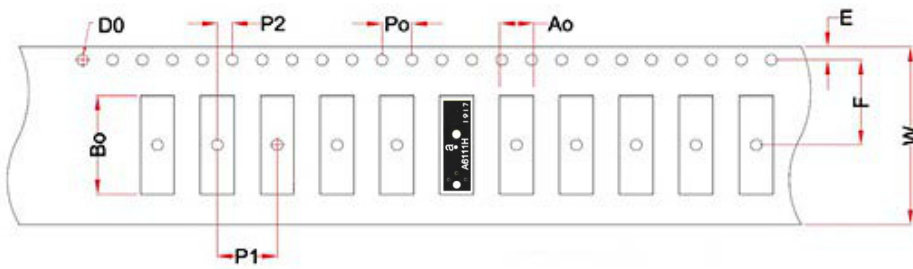

P0	P1	P2	D0
4.00 ± 0.1	8.00 ± 0.1	2.00 ± 0.1	1.50 ± 0.1

E	F	W
1.75 ± 0.1	10.20 ± 0.1	24.00 ± 0.3

All dimensions in (mm)

Quantity	Leading Space	Trailing space
2000 pcs / reel	50 blank antenna holders	37 blank antenna holders

15.3. Reel dimensions

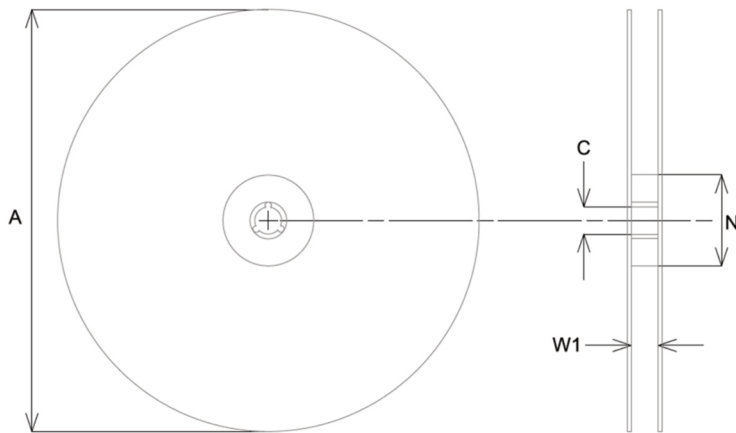

A	C	N	W1
330.0 ± 2.0	13.2 ± 0.5	100.0 ± 0.5	24.0 ± 0.3

All dimensions in (mm)

15.4. Box dimensions

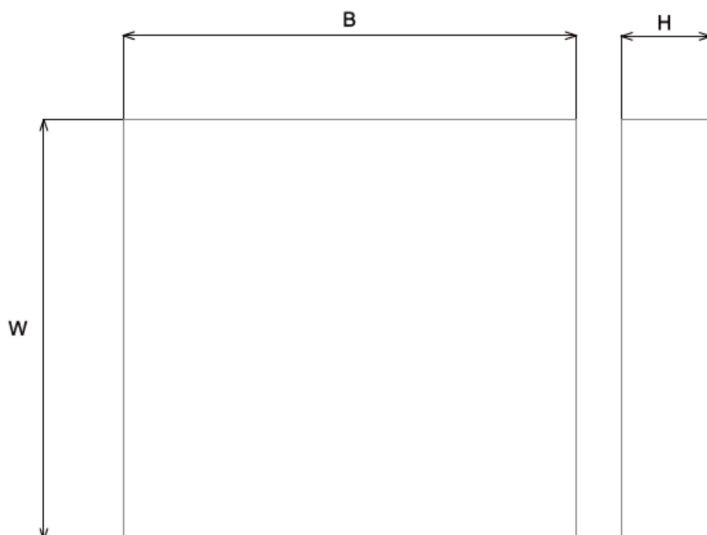

Width (W)	Breadth (B)	Height (H)
345mm	345mm	45mm

15.5. Bag properties

Reels are supplied in protective plastic packaging.

15.6. Reel label information



Quality statements

Antenova’s products conform to REACH and RoHS legislation. For our statements regarding these and other quality standards, please see antenova.com.

Antenova reserves all rights to the contents of this document. Antenova gives no warranties based solely on the accuracy or completeness of the contents of this document and reserves the right to make changes to the specifications of the products described herein at any time and without notice.



Datasheet version

3.04 released 25th May 2026

Antenna design, integration and test resources

Product designers – the details contained in this datasheet will help you to complete your embedded antenna design. Please follow our technical advice carefully to obtain optimum antenna performance.

We aim to support our customers to create high performance wireless products. You will find a wealth of design resources, calculators and case studies to aid your design on our website.

Antenova's design laboratories are equipped with the latest antenna design tools and test chambers. We provide antenna design, test and technical integration services to help you complete your design and obtain the required certifications.

If you cannot find the antenna you require in our product range, please contact us to discuss creating a custom antenna to meet your exact requirements.

Share knowledge with RF Experts around the world

ask.antenova is a global forum for
designers and engineers working with
wireless technology

[Visit Ask.Antenova](#)

Visit [antenova.com](https://www.antenova.com)

**Order antenna samples and
evaluation boards, and read our
antenna resources**

[Visit antenova.com](https://www.antenova.com)

Request a volume quotation for antennas:

[**sales@antenova.com**](mailto:sales@antenova.com)

+ 44 (0) 23 9400 1023

Global headquarters

**Antenova Ltd, 7 The Briars,
Waterberry Drive, Waterlooville,
Hampshire, PO7 7YH**